

Quick Start Guide

5-inch Visible Light Product

Version: 1.0

Date: August 2019

Overview

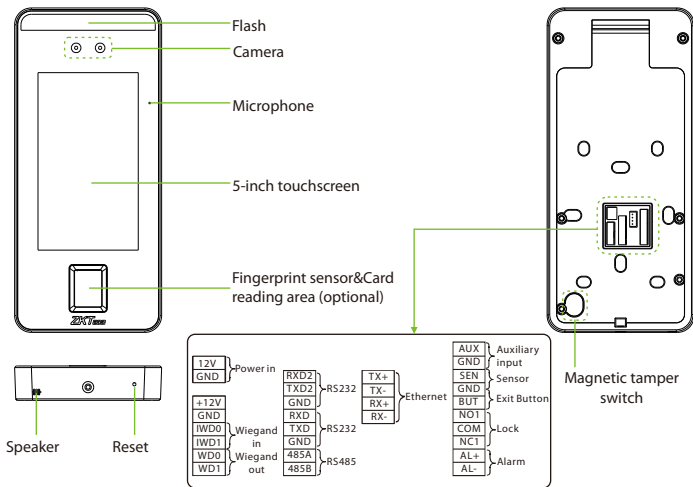

Device Installation

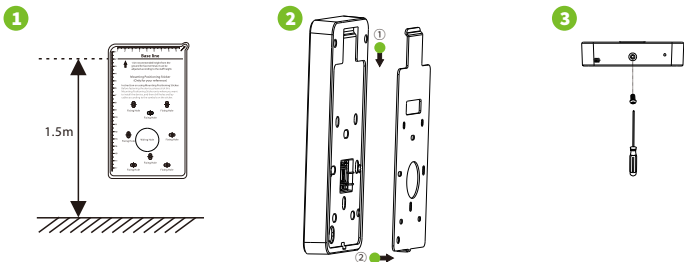

- ① Attach the mounting template sticker to the wall, and drill holes according to the mounting paper. Fix the back plate on the wall using wall mounting screws.
- ② Attach the device to the back plate.
- ③ Fasten the device to the back plate with a security screw.

Standalone Installation

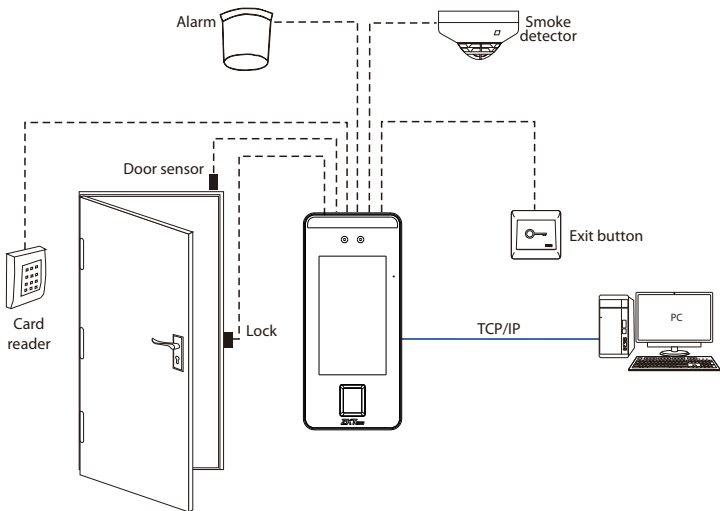

Door Sensor, Exit Button & Alarm Connection

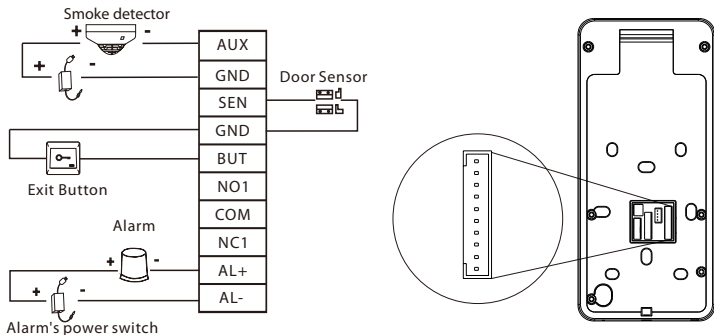

Lock Relay Connection

The system supports Normally Opened Lock and Normally Closed Lock.

The NO LOCK (normally opened at power on) is connected with 'NO1' and 'COM' terminals, and the NC LOCK (normally closed at power on) is connected with 'NC1' and 'COM' terminals. Take NC Lock as an example below:

1) Device not sharing power with the lock

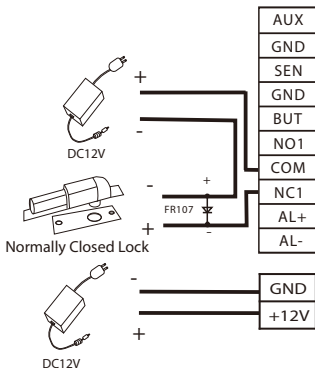

2) Device sharing power with the lock

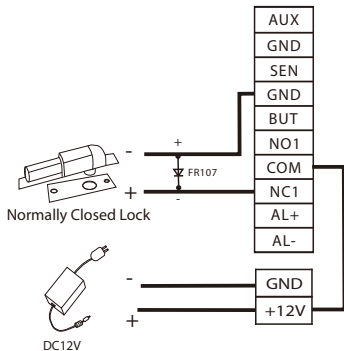

RS485 and RS232 Connection

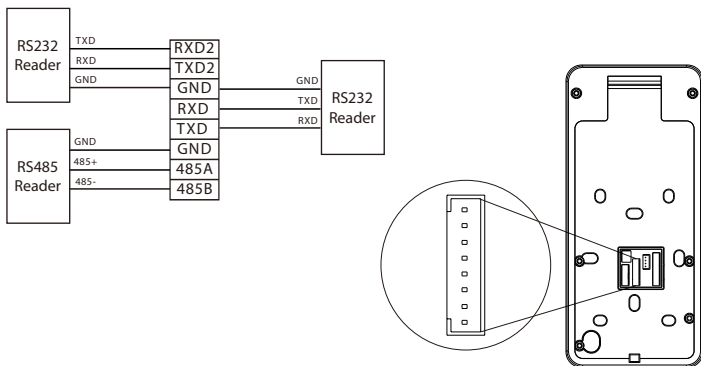

Wiegand Reader Connection

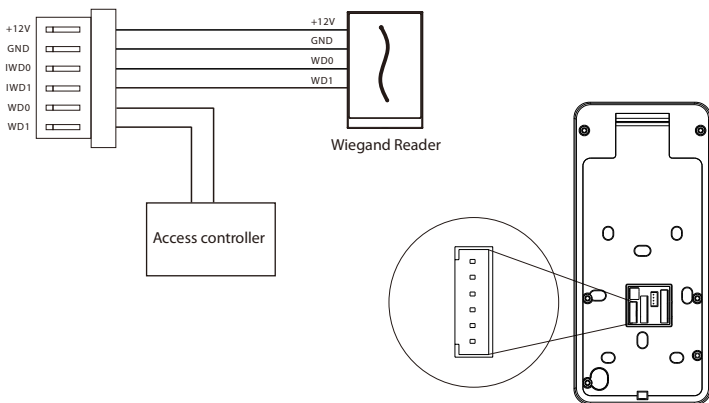

Power Connection

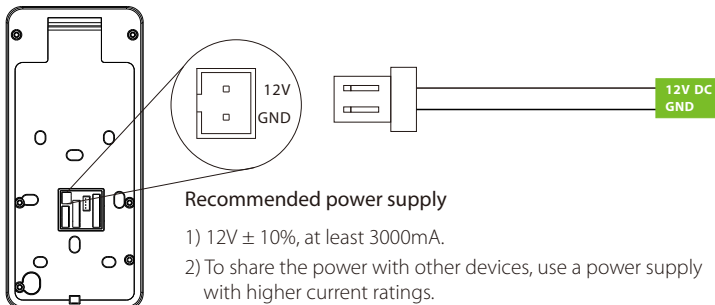

Ethernet Connection

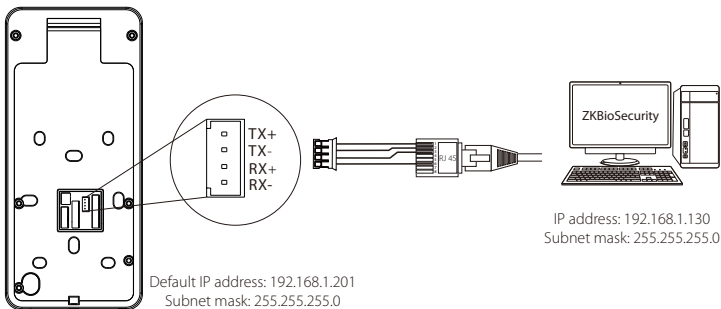

Click [COMM.] > [Ethernet] > [IP Address] , input the IP address and click [OK].

Note: In LAN, IP addresses of the server (PC) and the device must be in the same network segment when connecting to ZKBioSecurity software.

User Registration

When there is no super administrator set in the device, click on ☰ to enter the menu. After setting the super administrator, the system will request for the administrator's verification before entering the menu. For the security purpose, it is recommended to register a super administrator at the first time you use the device.

Method1: Register on the device

Click on ☰ > [User Mgt.] > [New User] to register a new user. Settings include entering user ID and name, registering a fingerprint, face, password, badge (optional) and user photo, setting user role and access control role.

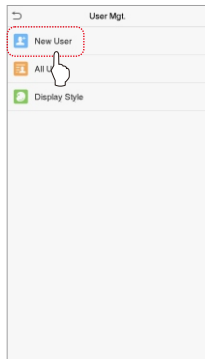
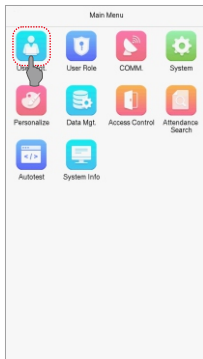
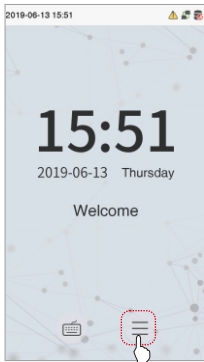

New User

User ID	2
Name	
User Role	Normal User
Fingerprint	0
Face	0
Password	
User Photo	0
Access Control Role	



Method2: Register on ZKBioSecurity software

Please set the IP address and cloud service server address on the device.

1. Click [Access] > [Access Device] > [Device] > [Search Device] to add the device to the software.

When the device has set the server address and port, it can be added automatically.

The screenshot shows the 'Search Device' window in the ZKBioSecurity software. The window title is 'Search Device'. At the top, there is a search bar and a 'Search' button. Below the search bar, there is a progress bar labeled 'Total Progress' which is at 100%. Below the progress bar, there are input fields for 'IP Address', 'Device Type', and 'Serial Number'. Below these fields, there is a table with columns: 'IP Address', 'MAC Address', 'Subnet Mask', 'Gateway Address', 'Serial Number', 'Device Model', and 'Server Address'. The table contains two rows of data. To the right of the table, there is an 'Add' button and a message 'This device has been added'. A callout box labeled 'Step 1' points to the 'Search Device' window title. A callout box labeled 'Step 2' points to the 'Search' button. A callout box labeled 'Step 3' points to the 'Add' button. A callout box labeled 'Step 4' points to the 'OK' button in the 'Add' dialog box.

The 'Add' dialog box is open, showing the following fields:

- Device Name*: 192.168.214.201
- New Server Address*: IP Address Domain Address
- New Server Port*: 8088
- Communication Password: [Empty]
- Area*: Area Name
- Add to Level: [Dropdown menu]
- Switch to Two-door Two-way:
- Clear Data in the Device when Adding:

A warning message is displayed: **⚠ [Clear Data in the Device when Adding] will delete data in the device (except event record), please use with caution!**

At the bottom of the dialog box, there are two buttons: 'OK' and 'Cancel'.

2. Click [Personnel] > [Person] > [New] to register users in the software.

3. Add users to access levels.

4. Click [Access] > [Device] > [Device Control] > [Synchronize All Data to Devices].

For more details, please refer to the ZKBioSecurity User Manual.

Method3: Register on the phone

Once ZKBioSecurity software installation, users could enroll face via browser application on their own mobile phone.

1. Click [Personnel] > [Parameters], input "http://Server address:Port" in the QR Code UGL bar. The software will automatically generates a QR code. Scan the QR code or login onto "http://Server address:Port/app/v1/adreg" by the mobile phone to register users.

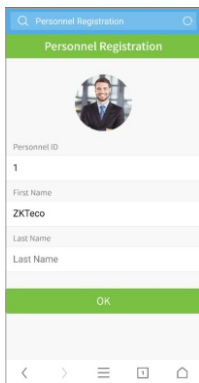

Personnel Registration

Personnel ID

1

First Name

ZKTeco

Last Name

Last Name

OK

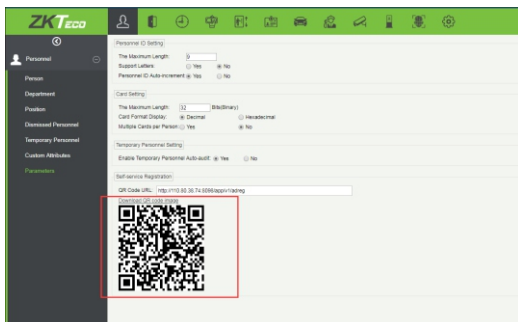

ZKTeco

Personnel ID Setting

The Maximum Length: (Binary)

Support Lashes: Yes No

Personnel ID Auto Increment: Yes No

Card Setting

The Maximum Length: (Binary)

Card Format Display: Decimal hexadecimal

Multiple Cards per Person: Yes No

Temporary Personnel Setting

Enable Temporary Personnel Auto-Quit: Yes No

Self-service Registration

QR Code URL:



2. The users will display in [Personnel] > [Temporary Personnel], click [Review].

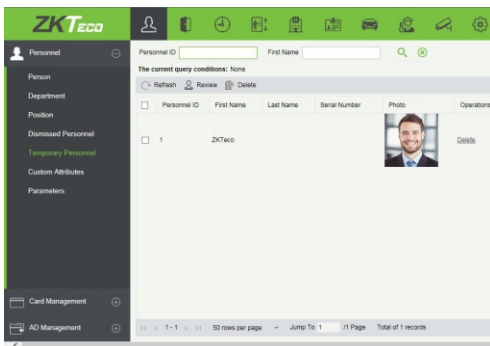

ZKTeco

Personnel ID First Name



The current query conditions: None



[Refresh](#) [Review](#) [Delete](#)

<input type="checkbox"/>	Personnel ID	First Name	Last Name	Serial Number	Photo	Operations
<input type="checkbox"/>	1	ZKTeco				Delete

50 rows per page - Jump To: 1 / 1 Page Total of 1 records

Ethernet and Cloud Server Settings

Click on  > [COMM.] > [Ethernet] to set the network parameters. If the TCP/IP communication of the device is successful, the icon  will be displayed in the upper right corner of the standby interface.

Click on  > [COMM.] > [Cloud Server Setting] to set the server address and server port, that is, the IP address and port number of the server after the software is installed. If the device communicates with the server successfully, the icon  will be displayed in the upper right corner of the standby interface.

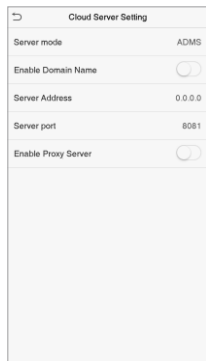
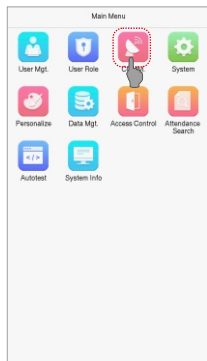

Access Control Settings

Click on  > [Access Control] to enter the access control management interface and set relevant parameters of access control.

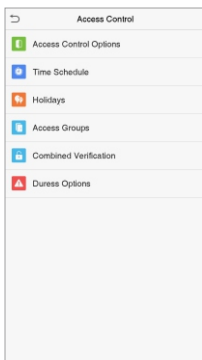
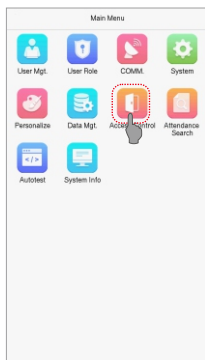

Records Query

Click on ☰ > [Attendance Search] > [Attendance Record] to enter the records query interface, input the user ID and select the time range, the corresponding attendance logs will be displayed.

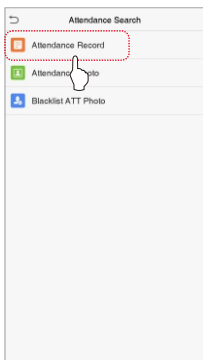
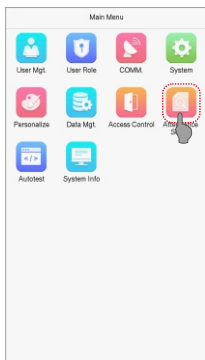

www.zkteco.eu